

RC series Thick Film Chip Resistor

◆ Features

- » Small size and light weight
- » Compatible with wave and reflow soldering
- » Suitable for lead free soldering
- » RoHS compliant & Halogen Free

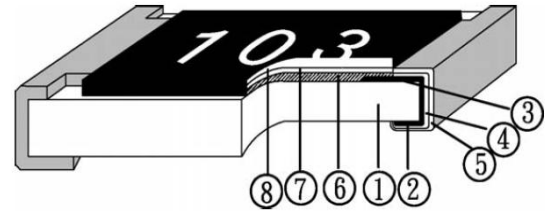

◆ Applications

- » Consumer Electronics
- » Measurement instrument
- » Computer

◆ Configuration

1	Alumina Substrate	5	External Electrode
2	Bottom Electrode	6	Resistor Layer
3	Top Electrode	7	Primary Overcoat
4	Barrier Layer	8	Secondary Overcoat

◆ Dimension

Unit: mm

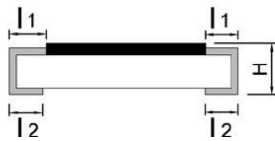
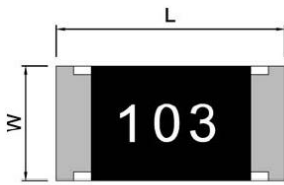

RC0201 / RC0402 / RC0603 / RC0805 / RC1206
RC1210 / RC1812 / RC2010 / RC2512

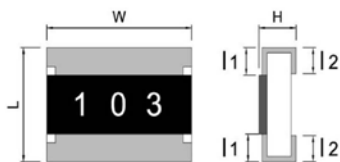

RC1218 / RC2030/RC0612

TYPE	L	W	H	l1	l2
RC0201	0.60±0.03	0.30±0.03	0.23±0.03	0.12±0.05	0.15±0.05
RC0402	1.00±0.10	0.50±0.05	0.30±0.05	0.20±0.10	0.25±0.10
RC0603	1.60±0.10	0.80±0.10	0.45±0.10	0.30±0.15	0.30±0.15
RC0805	2.00±0.10	1.25±0.10	0.50±0.10	0.35±0.20	0.35±0.15
RC1206	3.05±0.10	1.55±0.10	0.55±0.15	0.45±0.20	0.35±0.15
RC1210	3.05±0.10	2.55±0.10	0.55±0.10	0.50±0.20	0.50±0.20
RC1812	4.50±0.10	3.00±0.10	0.55±0.05	0.55±0.20	0.70±0.20
RC2010	5.00±0.20	2.50±0.20	0.55±0.10	0.60±0.20	0.60±0.20
RC1218	3.10±0.10	4.60±0.10	0.55±0.05	0.40±0.20	0.50±0.20
RC2512	6.40±0.20	3.20±0.20	0.60±0.15	0.60±0.25	0.90±0.25
RC2030	5.10±0.10	7.60±0.10	0.60±0.05	0.80±0.20	0.80±0.20
RC0612	1.60±0.20	3.20±0.20	0.55±0.10	0.30±0.20	0.50±0.20

◆ Power Derating Curve

»Type

RC0201

RC0402 / RC0603 / RC0805 / RC1206 / RC1210
RC1812 / RC2010 / RC1218 / RC2512 / RC2030
RC0612

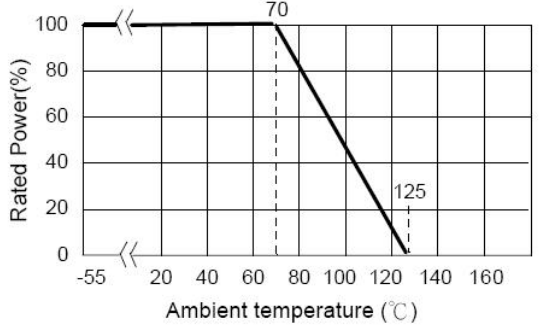
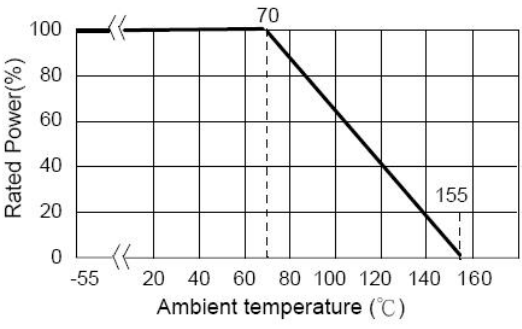
Operating Temperature Range	-55°C ~ +125°C	-55°C ~ +155°C
Explain	For resistors operated in ambient temperatures above 70°C, power rating shall be derated in accordance with figure below.	For resistors operated in ambient temperatures above 70°C, power rating shall be derated in accordance with figure below.
Figure		

◆ Voltage Rating or Current Rating Resistance

Range: $\geq 1\Omega$

Rated Voltage: The resistor shall have a DC continuous working voltage or a RMS AC continuous working voltage at commercial-line frequency and wave form corresponding to the power rating, as determined formula as following:

$$E = \sqrt{P \times R}$$

E=Rated voltage (V)
P=Power rating (W)
R=Nominal resistance(Ω)

◆ Soldering Profile

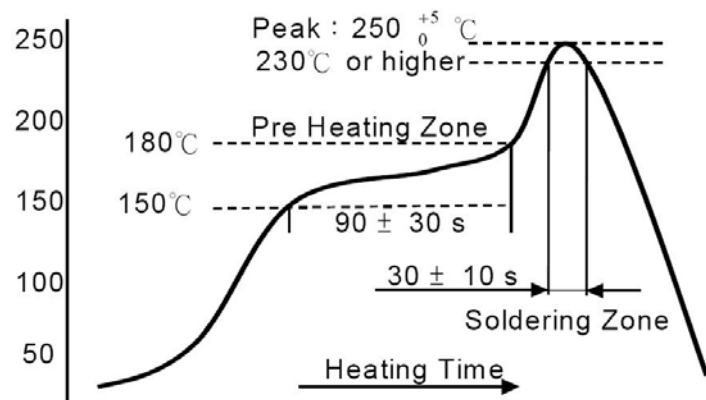

Rating

TYPE	Power Rating At 70°C (W)	Max Working Voltage	Max Overload Voltage	TCR (ppm/°C) Lower available	Resistance Range	
					1%	5%
RC0201	1/20 W (0.05 W)	25V	50V	-100~+350	$1\Omega \leq R < 10\Omega$	$1\Omega \leq R < 10\Omega$
				±200	$10\Omega \leq R \leq 10M\Omega$	$10\Omega \leq R \leq 10M\Omega$
RC0402	1/16 W (0.063 W)	50V	100V	0~+400	$1\Omega \leq R < 10\Omega$	$1\Omega \leq R < 10\Omega$
				±200	---	$10\Omega \leq R < 10M\Omega$
				±100	$10\Omega \leq R \leq 10M\Omega$	---
RC0603	1/10 W (0.1 W)	75V	100V	±400	$1\Omega \leq R < 10\Omega$	$1\Omega \leq R < 10\Omega$
				±200	---	$10\Omega \leq R \leq 10M\Omega$
				±100	$10\Omega \leq R \leq 10M\Omega$	---
RC0805	1/8 W (0.125 W)	150V	300V	±400	$1\Omega \leq R < 10\Omega$	$1\Omega \leq R < 10\Omega$
				±200	---	$10\Omega \leq R \leq 10M\Omega$
				±100	$10\Omega \leq R \leq 10M\Omega$	---
RC1206	1/4 W (0.25 W)	200V	400V	±400	$1\Omega \leq R < 10\Omega$	$1\Omega \leq R < 10\Omega$
				±200	---	$10\Omega \leq R \leq 10M\Omega$
				±100	$10\Omega \leq R \leq 10M\Omega$	---
RC1210	1/2 W (0.5 W)	200V	400V	±400	$1\Omega \leq R < 10\Omega$	$1\Omega \leq R < 10\Omega$
				±200	---	$10\Omega \leq R \leq 10M\Omega$
				±100	$10\Omega \leq R \leq 10M\Omega$	---
RC1812	3/4 W (0.75 W)	200V	400V	±400	$1\Omega \leq R < 10\Omega$	$1\Omega \leq R < 10\Omega$
				±200	---	$10\Omega \leq R \leq 10M\Omega$
				±100	$10\Omega \leq R \leq 10M\Omega$	---
RC2010	3/4 W (0.75 W)	200V	400V	±400	$1\Omega \leq R < 10\Omega$	$1\Omega \leq R < 10\Omega$
				±200	---	$10\Omega \leq R \leq 10M\Omega$
				±100	$10\Omega \leq R \leq 10M\Omega$	---
RC1218	1 W	200V	400V	±400	$1\Omega \leq R < 10\Omega$	$1\Omega \leq R < 10\Omega$
RC0612				0.75W	±200	---
RC2512	1W	200V	400V	±100	$10\Omega \leq R \leq 10M\Omega$	---
				±400	$1\Omega \leq R < 10\Omega$	$1\Omega \leq R < 10\Omega$
				±200	---	$10\Omega \leq R \leq 10M\Omega$
RC2030	2W	200V	400V	±100	$10\Omega \leq R \leq 10M\Omega$	---
				±400	$1\Omega \leq R < 10\Omega$	$1\Omega \leq R < 10\Omega$
				±200	---	$10\Omega \leq R < 10K\Omega$
±100	$10\Omega \leq R < 10K\Omega$	---				

TYPE	0201	0402	0603	0805	1206	1210	1812	2010	2512
Jumper Rated Current	0.5A	1A		2A					

TYPE	0612	1218	2030
Jumper Rated Current	4A	6A	10A

Note: Lower TCR is available for customer's requirement.

◆ Part Number

RC	0603	J	100K	□	□□
Type	Size	Tolerance	R VALUE	Reel Size	Package quantity
RC	0201	J=5%	1Ω= 1R	Blank = 7"	(Standard Package As below)
	0402	F=1%	10KΩ= 10K	B= 13"	10 = 10K per reel
	0603		2.2MΩ=2M2	C= 10"	20 = 20K per reel
	0805				08= 8K per reel
	1206				16= 16K per reel
	1210				
	1218				
	2512				
	2030				
	0612				

» Standard Package Q'ty for each size is as following.

TYPE	Standard Package Q'ty
RC0201	10K per reel
RC0402	10K per reel
RC0603	5K per reel
RC0805	5K per reel
RC1206	5K per reel
RC1210	5K per reel
RC1812	4K per reel
RC2010	4K per reel
RC1218	4K per reel
RC2512	4K per reel
RC2030	1K per reel
RC0612	5K per reel

◆ Specification

Specification and Test Methods

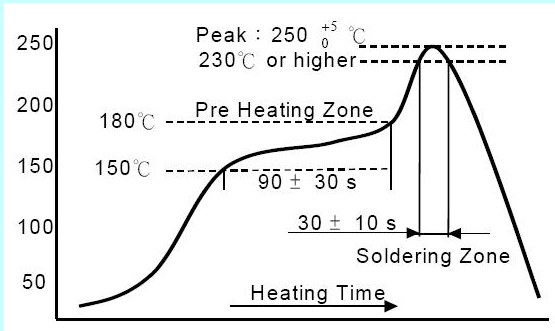
TEST ITEM	TEST METHOD	SPECIFICATON	REQUIREMENTS
Temperature Coefficient of Resistance (T.C.R)	JIS C 5201-1 clause 4.8	-55°C ~+155°C, 20°C is the reference temperature	Refer to Ratings
Short Time Overload	JIS C 5201-1 clause 4.13	General : 2.5 times RCWV or Max. Overload voltage for 5 seconds. High Power : 2.5 times RCWV or Max. Overload voltage for 2 seconds.	±1% : ±(1.0%+0.05Ω) ±5% : ±(2.0%+0.1Ω)
IR Reflow	Sony SS-00254	 <p>The graph shows a temperature profile for IR reflow. The y-axis is temperature in °C (50 to 250) and the x-axis is Heating Time. Key points include: a pre-heating zone starting at 150°C and reaching 180°C; a peak temperature of 250°C (with a tolerance of +5°C) or higher; a soldering zone with a duration of 30 ± 10 s; and a total heating time of 90 ± 30 s.</p>	±1% : ±(1.0%+0.05Ω) ±5% : ±(1.0%+0.05Ω)
Leaching	Sony SS-00254-9	260±5°C for 30 seconds.	>95% Coverage
Soldering Heat	JIS C 5201-1 clause 4.18	260±5°C for 10 seconds.	±1% : ±(0.5%+0.05Ω) ±5% : ±(1.0%+0.05Ω)
Temperature Cycling	JIS C 5201-1 clause 4.19	-55°C to +155°C, 5 cycles	±1% : ±(0.5%+0.05Ω) ±5% : ±(1.0%+0.10Ω)
Electric Iron	Sony SS-00254-5	Preheating temperature : 350±10°C Electric iron preheating time : 3+1/-0 sec	±1% : ±(1.0%+0.05Ω) ±5% : ±(1.0%+0.05Ω)
Resistance to Solvent	JIS C 5201-1 clause 4.29	The tested resistor be immersed into isopropyl alcohol of 20~25°C for 60 secs. Then the resistor is left in the room for 48 hrs.	±1% : ±(0.5%+0.05Ω) ±5% : ±(0.5%+0.05Ω)
Load Life in Humidity	JIS C 5201-1 clause 4.24	40±2°C, 90~95% R.H. or Max. working voltage for 1000 hrs with 1.5 hrs "ON" and 0.5 hr "OFF" .	±1% : ±(0.5%+0.05Ω) ±5% : ±(2.0%+0.05Ω)
Load Life (Endurance)	JIS C 5201-1 clause 4.25	70±2°C, or Max. working voltage for 1000 hrs with 1.5 hrs "ON" and 0.5 hr "OFF" .	±1% : ±(1.0%+0.05Ω) ±5% : ±(3.0%+0.10Ω)
Terminal Bending Strength	JIS C 5201-1 clause 4.33	Bending once for 5 seconds D : 0402、0603、0805=5mm 1206、1210、1812=3mm 0612、1218、2010、2512、2030=2mm	±1% : ±(1.0%+0.05Ω) ±5% : ±(1.0%+0.05Ω)
Insulation Resistance	JIS C 5201-1 clause 4.6	Max. Overload voltage for 1 minute.	≥ 10GΩ

◆ Packing

Tape Dimension

» Paper Carrier

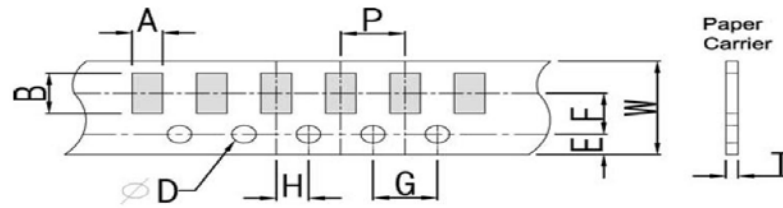

Unit: mm

TYPE	A	B	W	E	F	G	H	T	ϕD	P
RC0201	0.45± 0.1	0.75± 0.1	8.0± 0.2	1.75± 0.1	3.5± 0.05	4.0± 0.1	2.0± 0.05	0.35± 0.1	1.5± 0.1	2.0± 0.1
RC0402	0.70± 0.1	1.20± 0.1	8.0± 0.2	1.75± 0.1	3.5± 0.05	4.0± 0.1	2.0± 0.05	0.45± 0.1	1.5± 0.1	2.0± 0.1
RC0603	1.05± 0.2	1.80± 0.2	8.0± 0.2	1.75± 0.1	3.5± 0.05	4.0± 0.1	2.0± 0.05	0.60± 0.1	1.5± 0.1	4.0± 0.1
RC0805	1.55± 0.2	2.30± 0.2	8.0± 0.2	1.75± 0.1	3.5± 0.05	4.0± 0.1	2.0± 0.05	0.75± 0.1	1.5± 0.1	4.0± 0.1
RC1206 RC0612	1.90± 0.2	3.50± 0.2	8.0± 0.2	1.75± 0.1	3.5± 0.05	4.0± 0.1	2.0± 0.05	0.75± 0.1	1.5± 0.1	4.0± 0.1
RC1210	2.80± 0.2	3.50± 0.2	8.0± 0.2	1.75± 0.1	3.5± 0.05	4.0± 0.1	2.0± 0.05	0.75± 0.1	1.5± 0.1	4.0± 0.1

» Embossed Carrier

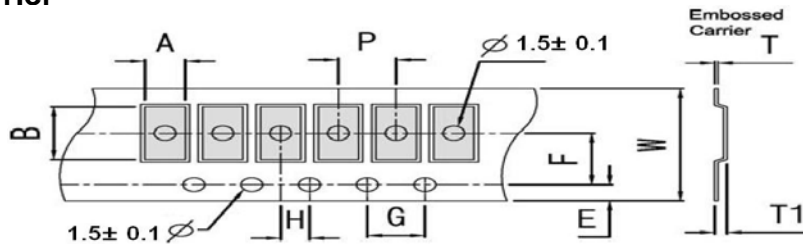

Unit: mm

TYPE	A	B	W	E	F	G	H	T	T1	P
RC1812	3.30± 0.2	4.60± 0.2	12.0± 0.2	1.75± 0.1	5.5± 0.05	4.0± 1	2.0± 0.05	0.23± 0.1	0.85± 0.15	4.0± 0.1
RC2010	2.80± 0.2	5.60± 0.2	12.0± 0.2	1.75± 0.1	5.5± 0.05	4.0± 1	2.0± 0.05	0.23± 0.1	0.85± 0.15	4.0± 0.1
RC1218	3.30± 0.2	4.60± 0.2	12.0± 0.2	1.75± 0.1	5.5± 0.05	4.0± 1	2.0± 0.05	0.23± 0.1	0.85± 0.15	4.0± 0.1
RC2512	3.40± 0.2	6.70± 0.2	12.0± 0.2	1.75± 0.1	5.5± 0.05	4.0± 1	2.0± 0.05	0.23± 0.1	0.85± 0.15	4.0± 0.1
RC2030	5.50± 0.2	7.90± 0.2	16.0± 0.2	1.75± 0.1	7.5± 0.05	4.0± 1	2.0± 0.05	0.25± 0.1	0.85± 0.15	8.0± 0.2

Lead Dimensions

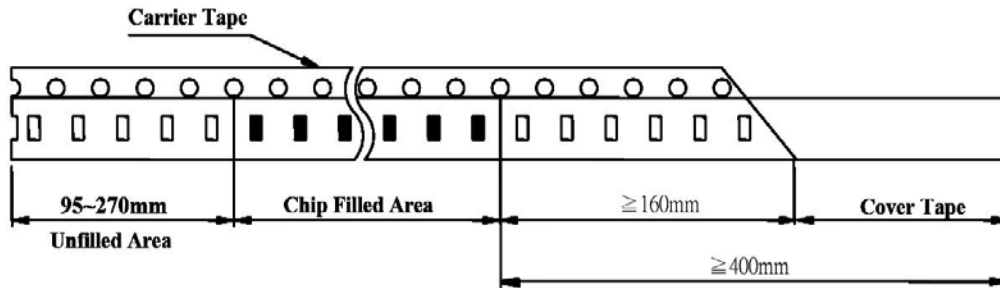

Top Adhesive Peel Off Strength : 10~70g

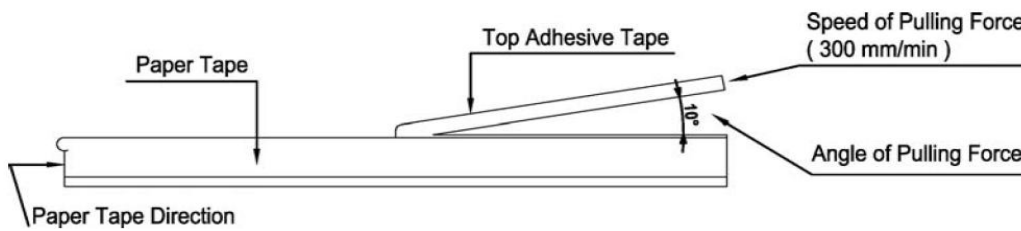

◆ Packing
Reel Dimensions

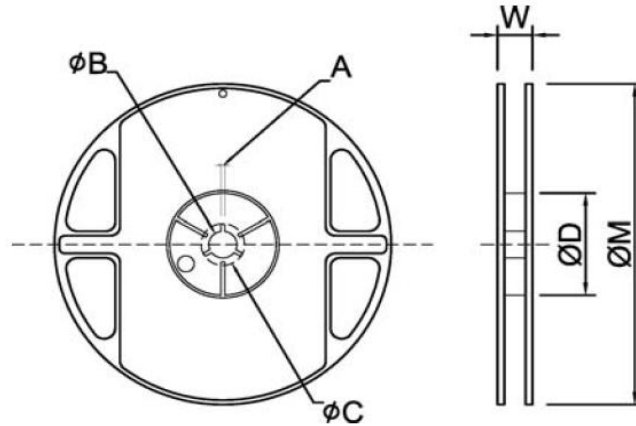

Unit: mm

TYPE	SIZE		A	ϕB	ϕC	ϕD	W	ϕM
RC0201	7"	15K/Reel	2.0±0.5	13.5±1.0	21±1.0	60±1.0	11.5±2.0	178±2.0
RC0402	7"	10K/Reel	2.0±0.5	13.5±1.0	21±1.0	60±1.0	11.5±2.0	178±2.0
	13"	30K/Reel	2.0±0.5	13.5±1.0	21±1.0	100±1.0	11.5±2.0	330±2.0
RC0603	7"	5K/Reel	2.0±0.5	13.5±1.0	21±1.0	60±1.0	11.5±2.0	178±2.0
RC0612	10"	10K/Reel	2.0±0.5	13.5±1.0	21±1.0	100±1.0	11.5±2.0	254±2.0
RC0805		10K/Reel	2.0±0.5	13.5±1.0	21±1.0	100±1.0	11.5±2.0	254±2.0
RC1206	13"	20K/Reel	2.0±0.5	13.5±1.0	21±1.0	100±1.0	11.5±2.0	330±2.0
RC1210		20K/Reel	2.0±0.5	13.5±1.0	21±1.0	100±1.0	11.5±2.0	330±2.0
RC1812	7"	4K/Reel	2.0±0.5	13.5±1.0	21±1.0	60±1.0	16.0±2.0	178±2.0
RC2010		4K/Reel	2.0±0.5	13.5±1.0	21±1.0	60±1.0	16.0±2.0	178±2.0
RC1218		4K/Reel	2.0±0.5	13.5±1.0	21±1.0	60±1.0	16.0±2.0	178±2.0
RC2512		4K/Reel	2.0±0.5	13.5±1.0	21±1.0	60±1.0	16.0±2.0	178±2.0
RC2030	7"	1K/Reel	2.0±0.5	13.5±1.0	21±1.0	60±1.0	19.0±2.0	178±2.0

RC series Thick Film High Ohm Chip Resistor

◆ Features

- » Small size and light weight.
- » Compatible with wave and reflow soldering.
- » Suitable for lead free soldering.
- » RoHS compliant & Halogen Free.

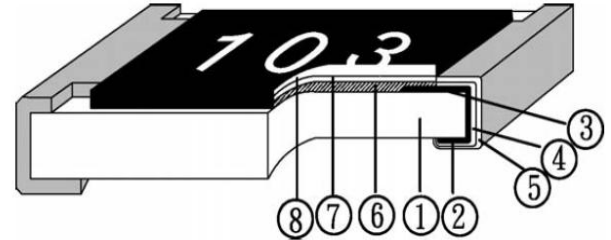

◆ Applications

- » Automotive industry.
- » Consumer Electronics.
- » Measurement instrument.
- » Computer.

◆ Configuration

1	Alumina Substrate	5	External Electrode
2	Bottom Electrode	6	Resistor Layer
3	Top Electrode	7	Primary Overcoat
4	Barrier Layer	8	Secondary Overcoat

◆ Dimension

Unit: mm

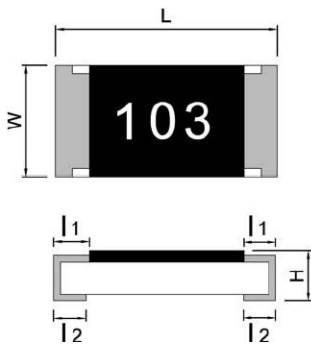

RC0402 / RC0603 / RC0805 / RC1206
RC1210 / RC2010 / RC2512

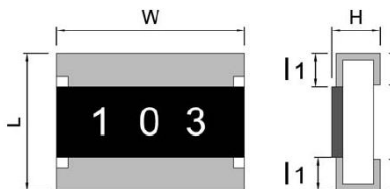

RC1218

TYPE	L	W	H	I1	I2
RC0402	1.00±0.01	0.50±0.05	0.30±0.05	0.20±0.10	0.25±0.10
RC0603	1.60±0.10	0.80±0.10	0.45±0.10	0.30±0.15	0.30±0.15
RC0805	2.00±0.10	1.25±0.10	0.50±0.10	0.35±0.20	0.35±0.15
RC1206	3.05±0.10	1.55±0.10	0.55±0.15	0.45±0.20	0.35±0.15
RC1210	3.05±0.10	2.55±0.10	0.55±0.10	0.50±0.20	0.50±0.20
RC2010	5.00±0.20	2.50±0.20	0.55±0.10	0.60±0.20	0.60±0.20
RC1218	3.10±0.10	4.60±0.10	0.55±0.05	0.40±0.20	0.50±0.20
RC2512	6.40±0.20	3.20±0.20	0.60±0.15	0.60±0.25	0.90±0.25

◆ Standard & High Power Electrical Specifications

TYPE	Power Rating At 70°C(W)		Max Working Voltage	Max Overload Voltage	TCR (ppm/°C) Lower Available	Resistance Range	
	Standard	High Power				1%	5%
RC0402	1/16 W (0.063 W)	-	50V	100V	±200	10.1M-30M	10.1M-30M
RC0603	1/10W (0.1W)	1/8 W (0.125 W)	50V	100V	±200	10.1M-30M	10.1M-30M
RC0805	1/8 W (0.125 W)	1/4 W (0.25 W)	150V	300V	±200	10.1M-30M	10.1M-30M
RC1206	1/4 W (0.25 W)	1/2 W (0.5 W)	200V	400V	±200	10.1M-30M	10.1M-30M
RC1210	1/3 W (0.33 W)	1/1.5W (0.66W)	200V	400V	±200	10.1M-30M	10.1M-30M
RC2010	3/4 W (0.75 W)	1W	200V	400V	±200	10.1M-30M	10.1M-30M
RC1218	1W	-	200V	400V	±200	10.1M-30M	10.1M-30M
RC2512	1W	2W	200V	400V	±200	10.1M-30M	10.1M-30M

- Note: Lower TCR value is available for customer's requirement.

◆ Part Number

RC	0603	J	20M	□	□□
Type	Size	Tolerance	R VALUE	Reel Size	Package quantity
RC	0402	J=5%	20MΩ= 20M	Blank = 7"	(Standard Package As below)
	0603	F=1%		B= 13"	10 = 10K per reel
	0805			C= 10"	20 = 20K per reel
	1206				08= 8K per reel
	1210				16= 16K per reel
	1218				
	2512				

» Standard Package Q'ty for each size is as following.

TYPE	Standard Package Q'ty
RC0402	10K per reel
RC0603	5K per reel
RC0805	5K per reel
RC1206	5K per reel
RC1210	5K per reel
RC2010	4K per reel
RC1218	4K per reel
RC2512	4K per reel

◆ Specification

Specification and Test Methods

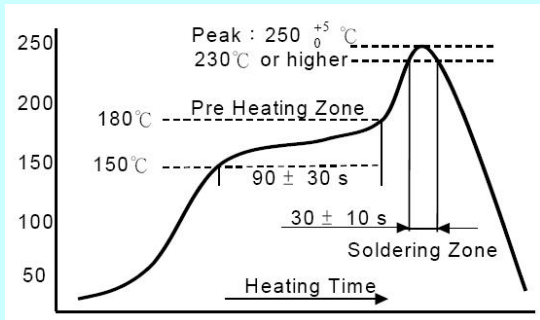
TEST ITEM	TEST METHOD	SPECIFICATON	REQUIREMENTS
Temperature Coefficient of Resistance (T.C.R)	JIS C 5201-1 clause 4.8	-55°C ~+155°C, 20°C is the reference temperature	Refer to Ratings
Short Time Overload	JIS C 5201-1 clause 4.13	General : 2.5 times RCWV or Max. Overload voltage for 5 seconds. High Power : 2.5 times RCWV or Max. Overload voltage for 2 seconds.	±1% : ±(1.0%+0.05Ω) ±5% : ±(2.0%+0.1Ω)
IR Reflow	Sony SS-00254	 <p>The graph shows a temperature profile for IR reflow. The y-axis is temperature in °C (50 to 250) and the x-axis is Heating Time. Key points include: a pre-heating zone reaching 150°C, a 90 ± 30 s dwell at 180°C, a peak of 250⁺⁵/₀°C (230°C or higher), and a soldering zone with a 30 ± 10 s dwell.</p>	±1% : ±(1.0%+0.05Ω) ±5% : ±(1.0%+0.05Ω)
Leaching	Sony SS-00254-9	260±5°C for 30 seconds.	>95% Coverage
Soldering Heat	JIS C 5201-1 clause 4.18	260±5°C for 10 seconds.	±1% : ±(0.5%+0.05Ω) ±5% : ±(1.0%+0.05Ω)
Temperature Cycling	JIS C 5201-1 clause 4.19	-55°C to +155°C, 5 cycles	±1% : ±(0.5%+0.05Ω) ±5% : ±(1.0%+0.10Ω)
Electric Iron	Sony SS-00254-5	Preheating temperature : 350±10°C Electric iron preheating time : 3+1/-0 sec	±1% : ±(1.0%+0.05Ω) ±5% : ±(1.0%+0.05Ω)
Resistance to Solvent	JIS C 5201-1 clause 4.29	The tested resistor be immersed into isopropyl alcohol of 20~25°C for 60 secs. Then the resistor is left in the room for 48 hrs.	±1% : ±(0.5%+0.05Ω) ±5% : ±(0.5%+0.05Ω)
Load Life in Humidity	JIS C 5201-1 clause 4.24	40±2°C, 90~95% R.H. or Max. working voltage for 1000 hrs with 1.5 hrs "ON" and 0.5 hr "OFF" .	±1% : ±(0.5%+0.05Ω) ±5% : ±(2.0%+0.05Ω)
Load Life (Endurance)	JIS C 5201-1 clause 4.25	70±2°C, or Max. working voltage for 1000 hrs with 1.5 hrs "ON" and 0.5 hr "OFF" .	±1% : ±(1.0%+0.05Ω) ±5% : ±(3.0%+0.10Ω)
Terminal Bending Strength	JIS C 5201-1 clause 4.33	Bending once for 5 seconds D : 0402、0603、0805=5mm 1206、1210=3mm 1218、2010、2512=2mm	±1% : ±(1.0%+0.05Ω) ±5% : ±(1.0%+0.05Ω)
Insulation Resistance	JIS C 5201-1 clause 4.6	Max. Overload voltage for 1 minute.	≥ 10GΩ

◆ Packing

Tape Dimension » Paper Carrier

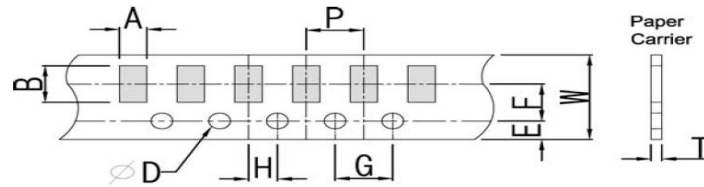

Unit: mm

TYPE	A	B	W	E	F	G	H	T	ϕD	P
RC0402	0.70± 0.1	1.20± 0.1	8.0± 0.2	1.75± 0.1	3.5± 0.05	4.0± 0.1	2.0± 0.05	0.45± 0.1	1.5± 0.1	2.0± 0.1
RC0603	1.05± 0.2	1.80± 0.2	8.0± 0.2	1.75± 0.1	3.5± 0.05	4.0± 0.1	2.0± 0.05	0.60± 0.1	1.5± 0.1	4.0± 0.1
RC0805	1.55± 0.2	2.30± 0.2	8.0± 0.2	1.75± 0.1	3.5± 0.05	4.0± 0.1	2.0± 0.05	0.75± 0.1	1.5± 0.1	4.0± 0.1
RC1206	1.90± 0.2	3.50± 0.2	8.0± 0.2	1.75± 0.1	3.5± 0.05	4.0± 0.1	2.0± 0.05	0.75± 0.1	1.5± 0.1	4.0± 0.1
RC1210	2.85± 0.2	3.50± 0.2	8.0± 0.2	1.75± 0.1	3.5± 0.05	4.0± 0.1	2.0± 0.05	0.75± 0.1	1.5± 0.1	4.0± 0.1

» Embossed Carrier

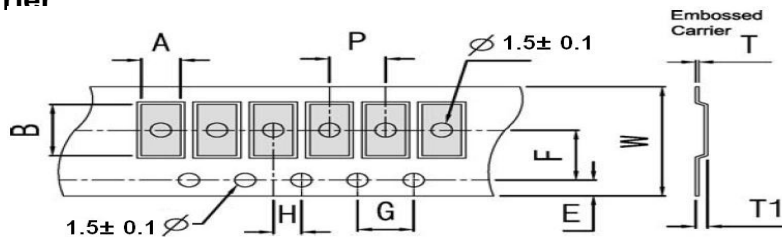

Unit: mm

TYPE	A	B	W	E	F	G	H	T	T1	P
RC2010	2.80± 0.2	5.60± 0.2	12.0± 0.2	1.75± 0.1	5.5± 0.05	4.0± 1	2.0± 0.05	0.23± 0.1	0.85± 0.15	4.0± 0.1
RC1218	3.30± 0.2	4.60± 0.2	12.0± 0.2	1.75± 0.1	5.5± 0.05	4.0± 1	2.0± 0.05	0.23± 0.1	0.85± 0.15	4.0± 0.1
RC2512	3.40± 0.2	6.70± 0.2	12.0± 0.2	1.75± 0.1	5.5± 0.05	4.0± 1	2.0± 0.05	0.23± 0.1	0.85± 0.15	4.0± 0.1

Lead Dimensions

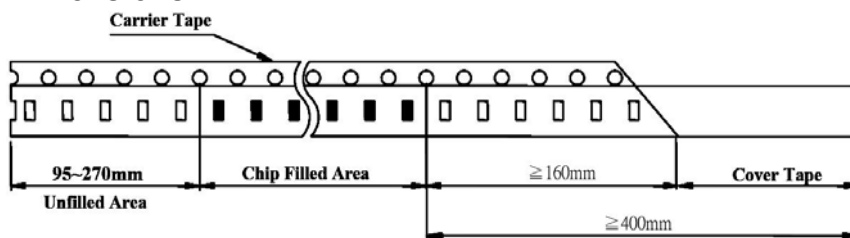

Top Adhesive Peel Off Strength : 10~70g

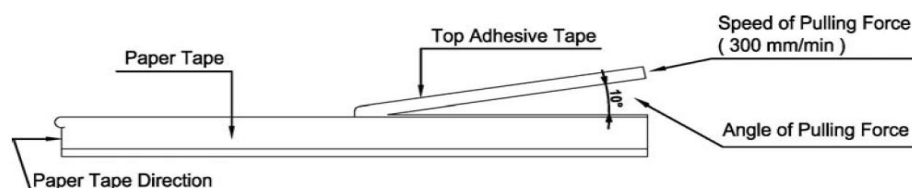

◆ **Packing**
Reel Dimensions

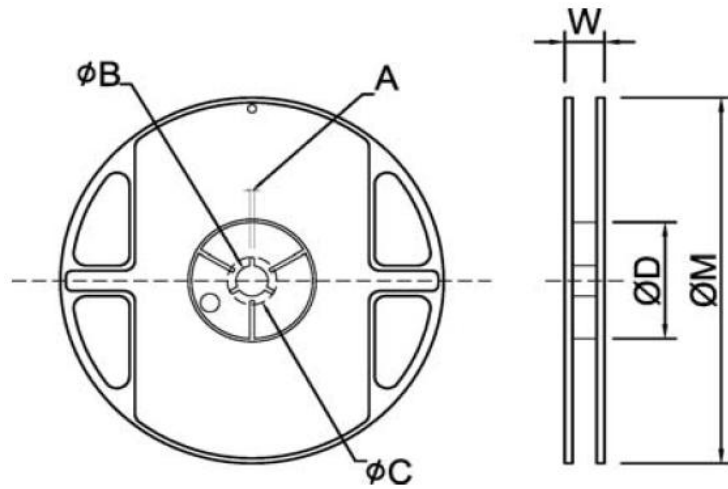

Unit: mm

TYPE	SIZE		A	ϕB	ϕC	ϕD	W	ϕM
RC0402	7"	10K/Reel	2.0±0.5	13.5±1.0	21±1.0	60±1.0	11.5±2.0	178±2.0
RC0603 RC0805 RC1206 RC1210	7"	5K/Reel	2.0±0.5	13.5±1.0	21±1.0	60±1.0	11.5±2.0	178±2.0
RC2010 RC1218 RC2512	7"	4K/Reel	2.0±0.5	13.5±1.0	21±1.0	60±1.0	16.0±2.0	178±2.0

RC series Thick Film Low Ohm Chip Resistor

◆ Features

- » Low inductance
- » Highly reliable multilayer electrode construction
- » Higher component and equipment reliability
- » Reduced size of final equipment reliability

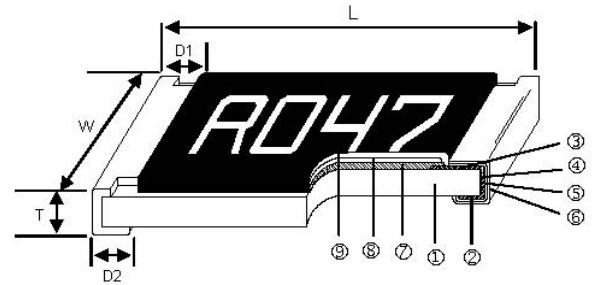

◆ Applications

- » Power Management Applications
- » Switching Power Supply
- » Over Current Protection in Audio Application
- » Voltage Regulation Module (VRM)
- » DC-DC Converter, Battery Pack, Charger Adaptor
- » Automotive Engine Control
- » Disk Driver

◆ Configuration

1	Alumina Substrate	6	External Electrode
2	Bottom Electrode	7	Resistor Layer
3	Top Electrode	8	Primary Overcoat
4	Edge Electrode	9	Secondary Overcoat
5	Barrier Layer		

◆ Dimension

Unit: mm

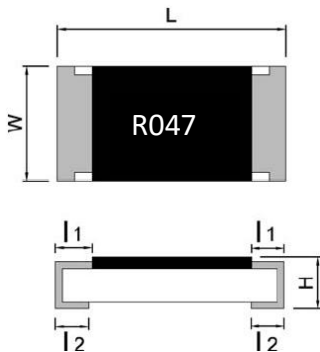

RC0402 / RC0603 / RC0805 / RC1206
RC1210 / RC1812 / RC2010 / RC2512

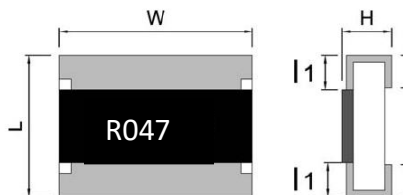

RC1218

TYPE	L	W	H	I1	I2
RC0402	1.00±0.01	0.50±0.05	0.30±0.05	0.20±0.10	0.25±0.10
RC0603	1.60±0.10	0.80±0.10	0.45±0.10	0.30±0.15	0.30±0.15
RC0805	2.00±0.10	1.25±0.10	0.50±0.10	0.35±0.20	0.35±0.15
RC1206	3.05±0.10	1.55±0.10	0.55±0.15	0.45±0.20	0.35±0.15
RC1210	3.05±0.10	2.55±0.10	0.55±0.10	0.50±0.20	0.50±0.20
RC1812	4.50±0.10	3.00±0.10	0.55±0.05	0.55±0.20	0.70±0.20
RC2010	5.00±0.20	2.50±0.20	0.55±0.10	0.60±0.20	0.60±0.20
RC1218	3.10±0.10	4.60±0.10	0.55±0.05	0.40±0.20	0.50±0.20
RC2512	6.40±0.20	3.20±0.20	0.60±0.15	0.60±0.25	0.90±0.25

◆ Standard Electrical Specifications

TYPE	Power Rating At 70°C (W)	Max Working Voltage	Max Overload Voltage	TCR (ppm/°C) Lower available	Resistance Range (mΩ)	
					1%	5%
RC0402	1/16 W (0.063 W)	0.25V	0.624V	±1000	50~990	50~990
RC0603	1/10 W (0.1 W)	0.31V	0.775V	±1200	20~47	20~47
				±1000	50~330	50~330
				±600	332~510	332~510
				±600	511~990	511~990
RC0805	1/8 W (0.125 W)	0.35V	0.875V	±1800	10~18	10~18
				±1800	20~50	20~50
				±800	51~99	51~99
				±600	100~330	100~330
				±600	332~990	332~990
RC1206	1/4 W (0.25 W)	0.5V	1.25V	±1800	10~18	10~18
				±1800	20~47	20~47
				±800	50~91	50~91
				±600	100	100
				±600	102~990	102~990
RC1210	1/2 W (0.5 W)	0.57V	1.425V	±1800	10~18	10~18
				±800	20~91	20~91
				±600	100	100
				±600	102~990	102~990
RC1812	3/4 W (0.75 W)	0.7V	1.75V	±1800	10~50	10~50
				±800	51~100	51~100
				±600	101~330	101~330
				±600	332~990	332~990
RC2010	3/4 W (0.75 W)	0.7V	1.75V	±1800	10~18	10~18
				±800	20~100	20~100
				±600	102~330	102~330
				±600	332~990	332~990
RC1218	1 W	0.99V	2.475V	±1800	10~50	10~50
				±800	51~990	51~990
RC2512	1W	0.99V	2.475V	±1800	10~18	10~18
				±800	20~91	20~91
				±600	100	100
				±600	102~990	102~990

● Note: Lower TCR value is available for customer's requirement.

◆ High Power Electrical Specifications

TYPE	Power Rating At 70°C (W)	Max Working Voltage	Max Overload Voltage	TCR (ppm/°C) Lower available	Resistance Range (mΩ)	
					1%	5%
RC0402	1/10 W (0.1 W)	0.25V	0.624V	±1000	50~91	50~91
				±800	100~976	100~976
RC0603	1/8 W (0.125 W)	0.352V	0.879V	±1200	20~47	20~47
				±1000	50~91	50~91
RC0805	1/4 W (0.25 W)	0.497V	1.244V	±600	100~990	100~990
				±1800	10~18	10~18
RC1206	1/2 W (0.5 W)	0.704V	1.759V	±1800	20~47	20~47
				±1800	10~18	10~18
RC1210	2/3 W	0.808V	2.021V	±800	50~91	50~91
				±600	100~990	100~990
RC1812	1 W	0.995V	2.487V	±1800	10~18	10~18
				±800	20~91	20~91
RC2010	1W	0.995V	2.487V	±600	100~900	100~900
				±1800	10~50	10~50
RC2512	2W	1.407V	3.518V	±800	51~100	51~100
				±600	101~330	101~330
				±600	331~990	331~990
				±1800	10~18	10~18
				±800	20~91	20~91
				±600	100~900	100~900
				±1800	10~18	10~18
				±800	20~91	20~91
				±600	100~900	100~900

● Note: Lower TCR value is available for customer's requirement.

◆ Part Number

RC	0603	J	0R47	□	□□	
Type	Size	Tolerance	R VALUE	Reel Size	Package Quantity	Rated Power
RC	0402	J=5%	47mΩ= 0R47	Blank = 7"	(Standard Package As below)	Blank = normal
	0603	F=1%	0.1Ω= 0R1	B= 13"	10 = 10K per reel	V= 1/4W
	0805			C= 10"	20 = 20K per reel	U= 1/2W
	1206				08= 8K per reel	T = 1W
	1210				16= 16K per reel	S = 2W
	1218					
	2512					

» Standard Package Q'ty for each size is as following.

TYPE	Standard Package Q'ty
RC0402	10K per reel
RC0603	5K per reel
RC0805	5K per reel
RC1206	5K per reel
RC1210	5K per reel
RC1812	4K per reel
RC2010	4K per reel
RC1218	4K per reel
RC2512	4K per reel

◆ Specification

Specification and Test Methods

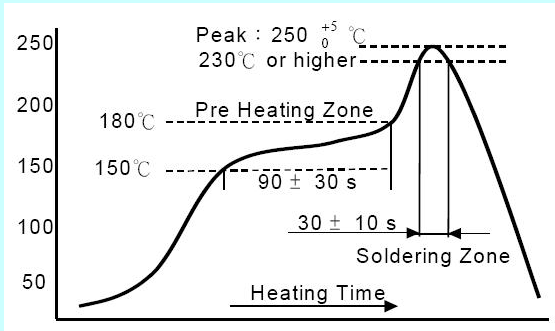
TEST ITEM	TEST METHOD	SPECIFICATON	REQUIREMENTS
Temperature Coefficient of Resistance (T.C.R)	JIS C 5201-1 clause 4.8	-55°C ~+155°C, 20°C is the reference temperature	Refer to Ratings
Short Time Overload	JIS C 5201-1 clause 4.13	General : 2.5 times RCWV or Max. Overload voltage for 5 seconds. High Power : 2.5 times RCWV or Max. Overload voltage for 2 seconds.	±1% : ±(1.0%+0.05Ω) ±5% : ±(2.0%+0.1Ω)
IR Reflow	Sony SS-00254	 <p>The graph shows a temperature profile for IR reflow. The y-axis is temperature in °C (50 to 250) and the x-axis is Heating Time. Key points include: Peak at 250⁺⁵°C (230°C or higher), Pre Heating Zone at 180°C, and a 90 ± 30 s dwell at 150°C. The Soldering Zone is defined by a 30 ± 10 s dwell at the peak temperature.</p>	±1% : ±(1.0%+0.05Ω) ±5% : ±(1.0%+0.05Ω)
Leaching	Sony SS-00254-9	260±5°C for 30 seconds.	>95% Coverage
Soldering Heat	JIS C 5201-1 clause 4.18	260±5°C for 10 seconds.	±1% : ±(0.5%+0.05Ω) ±5% : ±(1.0%+0.05Ω)
Temperature Cycling	JIS C 5201-1 clause 4.19	-55°C to +155°C, 5 cycles	±1% : ±(0.5%+0.05Ω) ±5% : ±(1.0%+0.10Ω)
Electric Iron	Sony SS-00254-5	Preheating temperature : 350±10°C Electric iron preheating time : 3+1/-0 sec	±1% : ±(1.0%+0.05Ω) ±5% : ±(1.0%+0.05Ω)
Resistance to Solvent	JIS C 5201-1 clause 4.29	The tested resistor be immersed into isopropyl alcohol of 20~25°C for 60 secs. Then the resistor is left in the room for 48 hrs.	±1% : ±(0.5%+0.05Ω) ±5% : ±(0.5%+0.05Ω)
Load Life in Humidity	JIS C 5201-1 clause 4.24	40±2°C, 90~95% R.H. or Max. working voltage for 1000 hrs with 1.5 hrs "ON" and 0.5 hr "OFF" .	±1% : ±(0.5%+0.05Ω) ±5% : ±(2.0%+0.05Ω)
Load Life (Endurance)	JIS C 5201-1 clause 4.25	70±2°C, or Max. working voltage for 1000 hrs with 1.5 hrs "ON" and 0.5 hr "OFF" .	±1% : ±(1.0%+0.05Ω) ±5% : ±(3.0%+0.10Ω)
Terminal Bending Strength	JIS C 5201-1 clause 4.33	Bending once for 5 seconds D : 0402、0603、0805=5mm 1206、1210、1812=3mm 1218、2010、2512=2mm	±1% : ±(1.0%+0.05Ω) ±5% : ±(1.0%+0.05Ω)
Insulation Resistance	JIS C 5201-1 clause 4.6	Max. Overload voltage for 1 minute.	≥ 10GΩ

◆ Packing

Tape Dimension

» Paper Carrier

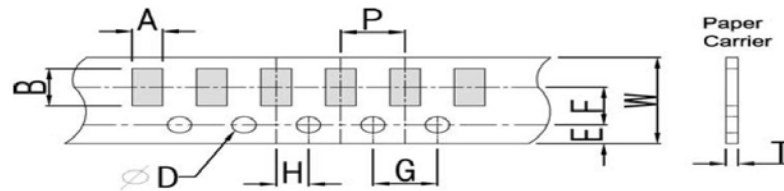

Unit: mm

TYPE	A	B	W	E	F	G	H	T	ϕD	P
RC0402	0.70± 0.1	1.20± 0.1	8.0± 0.2	1.75± 0.1	3.5± 0.05	4.0± 0.1	2.0± 0.05	0.45± 0.1	1.5± 0.1	2.0± 0.1
RC0603	1.05± 0.2	1.80± 0.2	8.0± 0.2	1.75± 0.1	3.5± 0.05	4.0± 0.1	2.0± 0.05	0.60± 0.1	1.5± 0.1	4.0± 0.1
RC0805	1.55± 0.2	2.30± 0.2	8.0± 0.2	1.75± 0.1	3.5± 0.05	4.0± 0.1	2.0± 0.05	0.75± 0.1	1.5± 0.1	4.0± 0.1
RC1206	1.90± 0.2	3.50± 0.2	8.0± 0.2	1.75± 0.1	3.5± 0.05	4.0± 0.1	2.0± 0.05	0.75± 0.1	1.5± 0.1	4.0± 0.1
RC1210	2.85± 0.2	3.50± 0.2	8.0± 0.2	1.75± 0.1	3.5± 0.05	4.0± 0.1	2.0± 0.05	0.75± 0.1	1.5± 0.1	4.0± 0.1

» Embossed Carrier

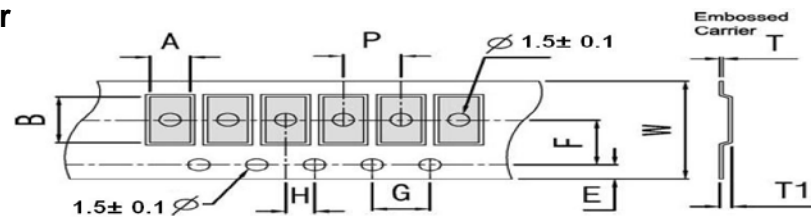

Unit: mm

TYPE	A	B	W	E	F	G	H	T	T1	P
RC1812	3.30± 0.2	4.60± 0.2	12.0± 0.2	1.75± 0.1	5.5± 0.05	4.0± 1	2.0± 0.05	0.23± 0.1	0.85± 0.15	4.0± 0.1
RC2010	2.80± 0.2	5.60± 0.2	12.0± 0.2	1.75± 0.1	5.5± 0.05	4.0± 1	2.0± 0.05	0.23± 0.1	0.85± 0.15	4.0± 0.1
RC1218	3.30± 0.2	4.60± 0.2	12.0± 0.2	1.75± 0.1	5.5± 0.05	4.0± 1	2.0± 0.05	0.23± 0.1	0.85± 0.15	4.0± 0.1
RC2512	3.40± 0.2	6.70± 0.2	12.0± 0.2	1.75± 0.1	5.5± 0.05	4.0± 1	2.0± 0.05	0.23± 0.1	0.85± 0.15	4.0± 0.1

Lead Dimensions

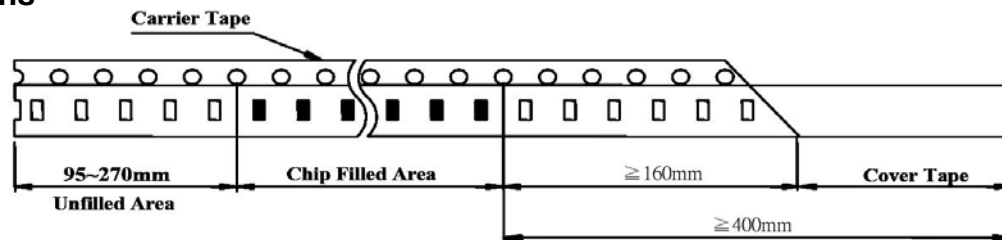

Top Adhesive Peel Off Strength : 10~70g

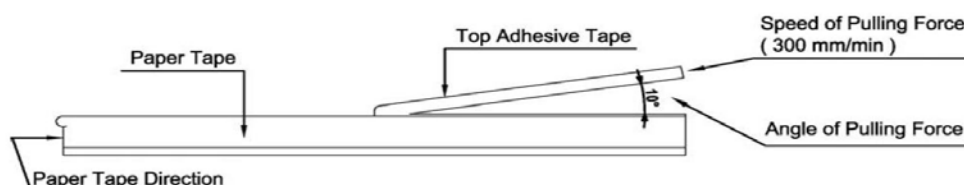

◆ **Packing**
Reel Dimensions

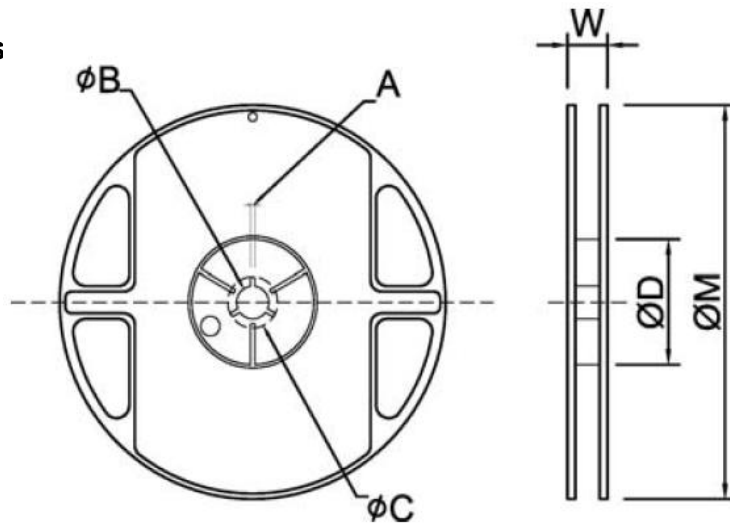

Unit: mm

TYPE	SIZE		A	ϕB	ϕC	ϕD	W	ϕM
RC0402	7"	10K/Reel	2.0±0.5	13.5±1.0	21±1.0	60±1.0	11.5±2.0	178±2.0
RC0603	7"	5K/Reel	2.0±0.5	13.5±1.0	21±1.0	60±1.0	11.5±2.0	178±2.0
RC0805								
RC1206								
RC1210								
RC1812	7"	4K/Reel	2.0±0.5	13.5±1.0	21±1.0	60±1.0	16.0±2.0	178±2.0
RC2010								
RC1218								
RC2512								