

# RTF series Thick Film Trimmable Chip Resistor

## ◆ Features

- » Small size and lightweight with size range per int'l standard
- » Highly stable in auto-placement surface mounting application
- » Suitable for fine tuning of the resistance value to obtain optimal circuit signals
- » RoHS compliant & Halogen Free

## ◆ Applications

- » Tuner
- » Camcorder
- » Photo sensor
- » Mobile phone
- » Portable audio
- » Portable measuring equipment

## ◆ Configuration

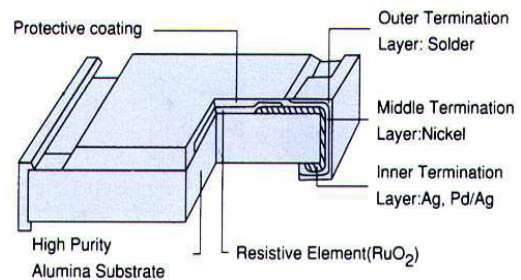

## ◆ Dimensions

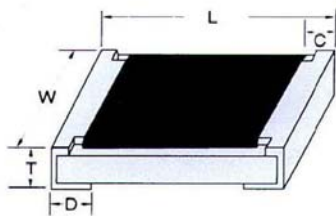

Size	L	W	C	D	T
0603	1.60±0.10	0.80±0.10	0.30±0.20	0.30±0.20	0.45±0.10
0805	2.00±0.10	1.25±0.10	0.40±0.20	0.40±0.20	0.50±0.10
1206	3.10±0.10	1.60±0.10	0.50±0.20	0.50±0.25	0.55±0.10
2010	5.00±0.20	2.60±0.20	0.60±0.25	0.60±0.25	0.60±0.10
2512	6.40±0.20	3.20±0.20	0.60±0.25	0.90±0.25	0.60±0.15

Unit: mm

## ◆ Power Derating Curve

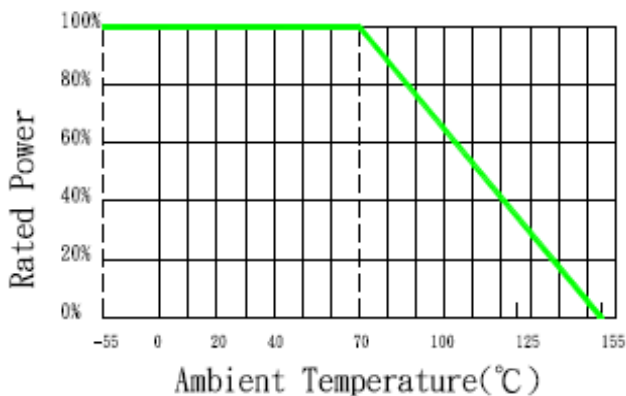

## ◆ Rating

Type	Power Rating at 70°C	Max. RCWV	Max. Overload Voltage	Resistance Tolerance (%)	Temperature Coefficient (ppm/°C)	Resistance Range		Standard Resistance Values
						Min.	Max.	
RTF0603	1/10W	50V	100V	0 ~ -30% (X) 0 ~ -20% (Y) 0 ~ -10% (Z)	± 100	10Ω	1MΩ	E-24
RTF0805	1/8W	150V	300V					
RTF1206	1/4W	200V	400V					
RTF2010	1/2W	200V	400V					
RTF2512	1W	200V	400V					

E = (P x R) 1/2      E : Working Voltage(V) , P : Rated Power (W), R: Resistance Value (Ω)

## ◆ Part Number

RTF	0805	Z	10K	□	□□
Type	Size	Tolerance	R Value	Reel Size	Package Quantity
RTF	0603	X: 0% ~ -30 %	10KΩ = 10K	Blank = 7"	(standard package As below) 10= 10K per reel 20= 20K per reel 08= 8K per reel 16= 16K per reel
	0805	Y: 0% ~ -20%	0Ω = 0R	B= 13"	
	1206	Z: 0% ~ -10%	2.2MΩ = 2M2	C= 10"	
	2010				
	2512				

» Standard Package Q'ty for each size is as following.

TYPE	Standard Package Q'ty
RTF0603	5K per reel
RTF0805	5K per reel
RTF1206	5K per reel
RTF2010	4K per reel
RTF2512	4K per reel

## ◆ Soldering Temperature Curve

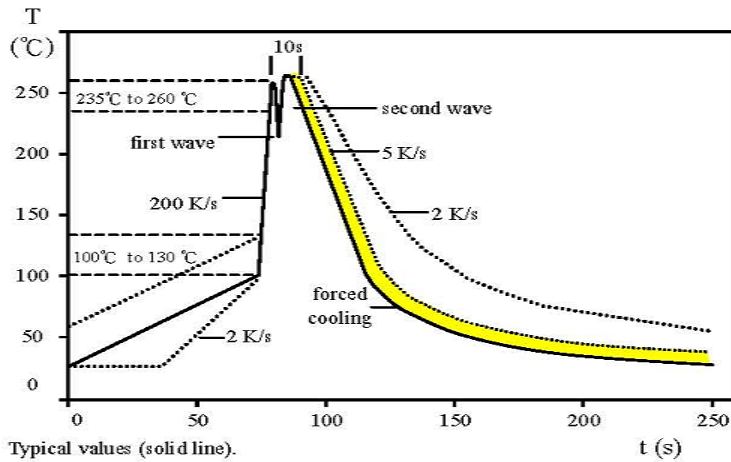

Typical values (solid line).

Process limits (dotted line).

WAVE soldering.

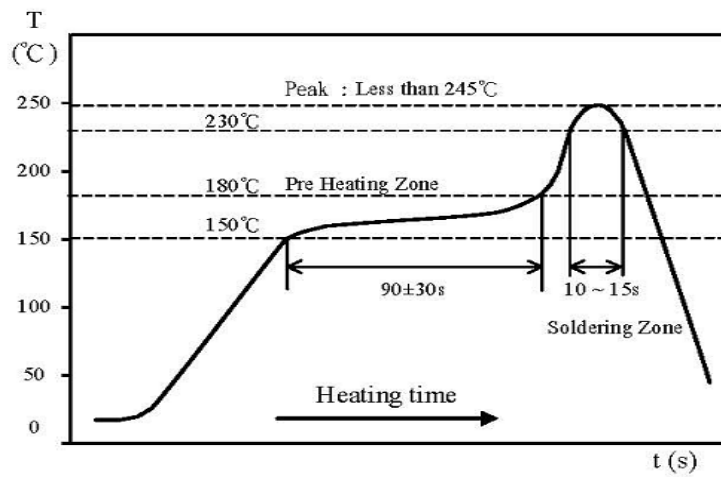

IR Reflow Soldering

## ◆ Specification

### Specification and Test Method

TEST	SPECIFICATION	TEST METHOD
DC Resistance	0 ~ -30% (X) 0 ~ -20% (Y) 0 ~ -10% (Z)	IEC 60115-1 / JIS C 5201-1 , Clause 4.5 Measure the resistance Value.
Short Time Overload	$\Delta R \leq \pm (2\% + 0.1\Omega)$	IEC 60115-1 / JIS C 5201-1 , Clause 4.13 2.5 × Rated voltage or Max. Overload Voltage for 5 sec. measure resistance after 30 minutes
Solderability	Over 95% of termination must be covered with solder	IEC 60115-1 / JIS C 5201-1, Clause 4.17 After immersing flux, dip in the 245±2°C molten solder bath for 3 ± 0.5 sec.
Resistance to solder Heat	$\Delta R \leq \pm (1\% + 0.1\Omega)$ No mechanical damage	IEC 60115-1 / JIS C 5201-1 , Clause 4.18 With 260 ± 5°C for 10 ± 1sec
Load Life Humidity	$\Delta R \leq \pm (3\% + 0.1\Omega)$	IEC 60115-1 / JIS C 5201-1 , Clause 4.24 Maintain the temperature of the resistor at 40±2°C and 90% ~ 95% R.H. with the rated voltage applied. Cycle ON for 1.5 hours and OFF for 0.5 hour for 1000+48/-0 hours. After 1 ~ 4 hours, measure the resistance value.
Temperature Coefficient of Resistance (TCR)	± 100 ppm/°C	IEC 60115-1 / JIS C 5201-1 , Clause 4.8 Test temperature : 25°C(T1) → -55°C(T2) 25°C(T1) → +155°C(T2) $TCR (ppm/^\circ C) = \frac{R2 - R1}{R1} \times \frac{1}{T2 - T1} \times 10^6$ T1: 25°C T2: Test temperature R1: Resistance at reference temperature (T1) T2: Resistance at test temperature (T2)
Load Life	$\Delta R \leq \pm(3\% + 0.1\Omega)$	IEC 60115-1 / JIS C 5201-1 , Clause 4.25 Permanent resistance change after 1000+48/-0 hours (1.5 hours ON, 0.5hour OFF) at RCWV or Max. Keep the resistor at 70 ± 2°C ambient.
Temperature Cycle	$\Delta R \leq \pm (1\% + 0.1\Omega)$ No mechanical damage	IEC 60115-1 / JIS C 5201-1 , Clause 4.19 Repeat 5 cycles as follows -55°C (30min.) → +25°C (2~3min.) → +155°C (30min.) → +25°C (2~3min.)
Insulation Resistance	Between termination and coating must be over 1000MΩ	IEC 60115-1 / JIS C 5201-1 , Clause 4.6 Test voltage : 100 ± 15V
Bending strength	$\Delta R \leq \pm(1\% + 0.1\Omega)$ No mechanical damage	IEC 60115-1 / JIS C 5201-1 , Clause 4.33 Resistance changes after bended on the 90mm PCB. Bend : 3mm for 0603, 0805, 2mm for 1206, 2010, 2512

## ◆ Packing

### Tape and Reel Package

Taping specs are according to EIA RS-481

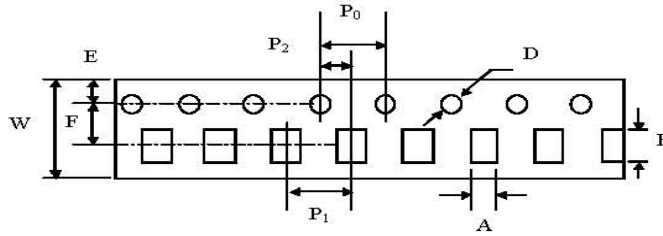

Accumulated dimensional tolerance  $40\pm 0.2\text{mm}$

Size	A	B	W	F	E	P1	P2	P0	D
0603	$1.10\pm 0.20$	$1.90\pm 0.20$	$8.00\pm 0.30$	$3.50\pm 0.05$	$1.75\pm 0.10$	$4.00\pm 0.10$	$2.00\pm 0.05$	$4.00\pm 0.10$	$1.50+0.10/-0$
0805	$1.65\pm 0.20$	$2.40\pm 0.20$	$8.00\pm 0.30$	$3.50\pm 0.05$	$1.75\pm 0.10$	$4.00\pm 0.10$	$2.00\pm 0.05$	$4.00\pm 0.10$	$1.50+0.10/-0$
1206	$2.00\pm 0.20$	$3.60\pm 0.20$	$8.00\pm 0.30$	$3.50\pm 0.05$	$1.75\pm 0.10$	$4.00\pm 0.10$	$2.00\pm 0.05$	$4.00\pm 0.10$	$1.50+0.10/-0$
2010	$2.80\pm 0.20$	$5.50\pm 0.20$	$12.00\pm 0.30$	$5.50\pm 0.05$	$1.75\pm 0.10$	$4.00\pm 0.10$	$2.00\pm 0.05$	$4.00\pm 0.10$	$1.50+0.10/-0$
2512	$3.50\pm 0.20$	$6.70\pm 0.20$	$12.00\pm 0.30$	$5.50\pm 0.05$	$1.75\pm 0.10$	$4.00\pm 0.10$	$2.00\pm 0.05$	$4.00\pm 0.10$	$1.50+0.10/-0$

Unit: mm

### Reel Package

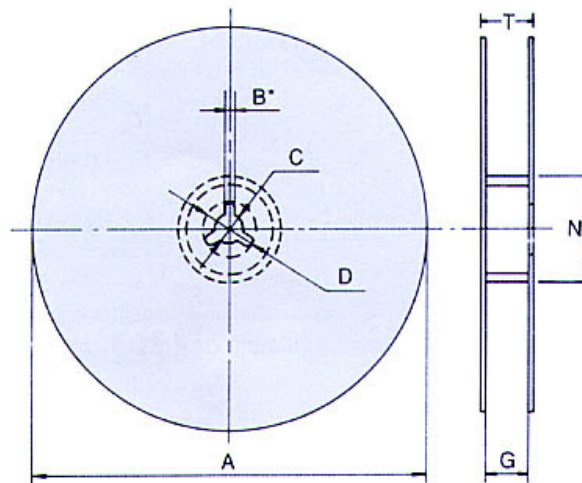

Size	Packing Q'ty	A	N	C	D	B	G	T
0603 0805 1206	5kpcs/Reel (7")	$178.0\pm 2.0$	$60.0\pm 0.5$	$13.0\pm 0.5$	20(Min.)	$2.0\pm 0.5$	$10.0\pm 1.5$	14.9max.
	10kpcs/Reel (10")	$254.0\pm 2.0$	$100.0\pm 0.5$	$13.5\pm 0.5$	20(Min.)	$2.0\pm 0.5$	$10.0\pm 1.5$	14.9max.
	20kpcs/Reel (13")	$330.0\pm 2.0$	$100.0\pm 1.0$	$13.5\pm 0.5$	20(Min.)	$2.0\pm 0.5$	$10.0\pm 1.5$	14.9max.
2010 2512	4kpcs/Reel (7")	$178.0\pm 2.0$	$60.0\pm 0.5$	$13.0\pm 0.5$	20(Min.)	$2.0\pm 0.5$	$13.8\pm 1.5$	16.7max.
	8kpcs/Reel (10")	$254.0\pm 2.0$	$100.0\pm 0.5$	$13.5\pm 0.5$	20(Min.)	$2.0\pm 0.5$	$13.8\pm 1.5$	20.0max.
	16kpcs/Reel (13")	$330.0\pm 2.0$	$100.0\pm 1.0$	$13.5\pm 0.5$	20(Min.)	$2.0\pm 0.5$	$13.8\pm 1.5$	20.0max.

Unit: mm